

Quick Reference MDrive® 34 Microstepping

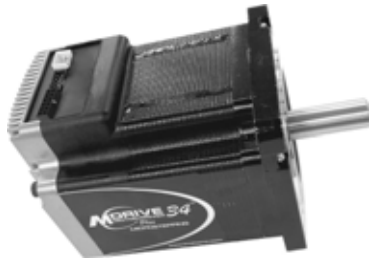

IMS
INTELLIGENT MOTION
SYSTEMS, INC.

Schneider
Electric

Notes and Warnings

Installation, configuration and maintenance must be carried out by qualified technicians only. You must have detailed information to be able to carry out this work. This information can be found in the user manual.

- Unexpected dangers may be encountered when working with this product!
- Incorrect use may destroy this product and connected components!

The user manual is not included, but may be obtained from the Internet at: <http://www.imshome.com/downloads/manuals.html>.

Required for Setup*

- PC running Microsoft® Windows XP Service Pack 2 or greater.
- SPI Motor Interface (available online).
- +12 to +75 VDC unregulated linear or switching power supply.
- 0 to 5 MHz clock signal for step clock, may be a controller high speed output or signal generator.
- SPST switch or controller I/O point to control axis direction.
- SPI communications interface (recommended: MD-CC300-001 or MD-CC303-001 communication converters).

Depending on your MDrive connectors configuration, you may also need:

- I/O, and Communications interface to 12-pin wire crimp connector. Recommended: PD12-1434-FL3 prototype development cable.
- Power interface to the 2-pin wire crimp connector (recommended PD02-3400-FL3 prototype development cable).

* If you purchased your MDrive with a QuickStart Kit, you have received all of the connecting cables needed for initial functional setup and system testing.

Getting Started

All documentation, software and resources are available online at: http://www.imshome.com/products/mdrive_motor_driver.html.

Connecting Power and I/O

Your MDrive may be configured with power and I/O combined on a single connector, or with separate connectors. Please refer to the opposite side of this document for connecting details and available connectivity options.

Connecting Communications

1. Connect IMS USB to SPI communications converter to MDrive and PC.
2. Install the communication converter drivers onto PC (available online).
3. Install and open SPI Motor Interface.
4. Apply power to MDrive.
5. Parameters may be adjusted via two screens, the Motor Settings screen or the I/O Settings screen (shown below), accessible via the View menu.

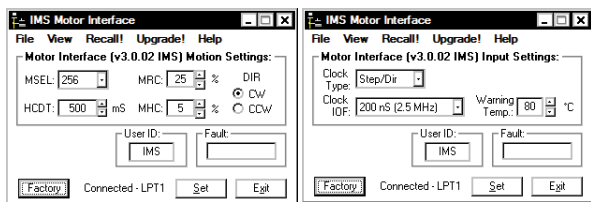

Motor Settings Screen

I/O Settings Screen

Specifications

Electrical Specifications

Input Voltage (+V) Range*	+12 to +75 VDC
Max Power Supply Current (Per MDrive 34)*	4 A

*Actual Power Supply Current will depend on voltage and load.

Environmental Specifications

Operating Temperature (non-condensing)	Heat Sink	-40°C to +75°C
	Motor	-40°C to +90°C

Isolated Input Specifications

Step Clock, Direction and Enable	
Voltage Range (Sinking or Sourcing)	+5 to +24 VDC
Current (+5V Max)	8.7 mA
Current (+24V Max)	14.6 mA

Motion Specifications

Digital Filter Range	50 nS to 12.9 µS (10 MHz to 38.8 kHz)
Clock Types	Step/Direction, Up/Down, Quadrature
Step Frequency (Max)	5 MHz
Step Frequency Minimum Pulse Width	100 nS
Number of Microstep Resolution Settings	20

Available Microsteps Per Revolution									
200	400	800	1000	1600	2000	3200	5000	6400	10000
12800	20000	25000	25600	40000	50000	51200	36000 ¹	21600 ²	25400 ³
1=0.01 deg/µstep			2=1 arc minute/µstep			3=0.001 mm/µstep			

Setup Parameters

Setup Parameters

Name	Function	Range	Units	Default
MHC	Motor Hold Current	0 to 100	Percent	5
MRC	Motor Run Current	1 to 100	Percent	25
MSEL	Microstep Resolution	See Motion Specifications	µsteps/ Full Step	256
DIR	Motor Direction Override	0/1	—	CW
HCDT	Hold Current Delay Time	0 or 2 - 65535	mSec	500
CLK TYPE	Clock Type	See Motion Specifications	—	Step/ Direction
CLK IOF	Clock Input Filter	50 nS to 12.9 µS (10 MHz to 38.8 kHz)	nS (MHz)	200 nS (2.5MHz)
EN ACT	Enable Active High/Low	High/Low	—	High
USER ID	User ID	3 Characters Viewable ASCII	Viewable ASCII	IMS
WARN TEMP	Over Temperature Warning	0 to 125	°C	80

Mechanical Specifications

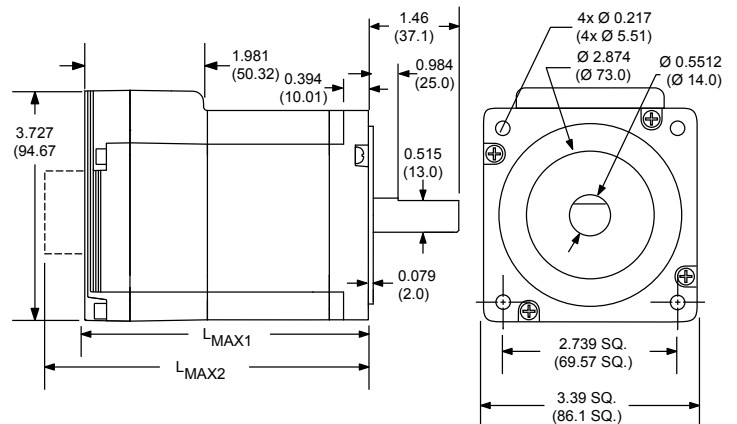

Motor Length	Dimensions in inches (mm)	
	LMAX1 (Single Shaft)	LMAX2 (Control Knob)
Single	3.81 (96.77)	4.52 (114.81)
Double	4.60 (116.84)	5.31 (134.87)
Triple	6.17 (156.72)	6.88 (174.75)

Minimum Required Connections

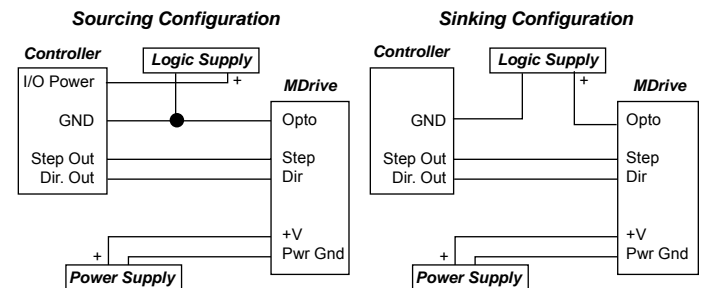

MDrive 34 Microstepping Connectivity Options

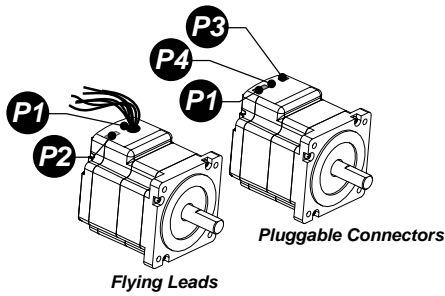

Connector Style	Function
P1 Flying Leads.....	I/O, Power & Encoder
P1 12-pin Wire Crimp.....	I/O and Communications
P2 10-pin IDC.....	Communications
P3 2-Pin Wire Crimp.....	Power
P4 10-pin Wire Crimp.....	Encoder

P1 I/O, Power and Optional Internal Encoder

Flying leads

Wire Color	Function
White	Opto Reference
Orange	Step Clock
Blue	CW/CCW Direction
Brown	Enable
Black	Ground
Red	+V

Wire Color	Single-End	Differential
Yellow/Black	GND	GND
Yellow/Violet	IDX	IDX+
Yellow/Blue	CH A	CH A+
Yellow/Red	+5 VDC	+5 VDC
Yellow/Brown	CH B	CH B+
Yellow/Gray	—	IDX -
Yellow/Green	—	CH A-
Yellow/Orange	—	CH B-

P1 I/O & Communications

12-pin wire crimp

CONNECTOR PRODUCT ALERT! October 2009
Disregard these pin number markings. Use the pin numbering scheme shown above.

The manufacturer of this 12-pin wire crimp connector has begun marking the connector shell, PN 1-794617-2 with pin numbers shown here.

Chip Select	11 12	SPI MISO
Comm Gnd	9 10	SPI MOSI
+5 VDC	7 8	SPI Clock
Enable	5 6	Direction
Opto Ref	3 4	Step Clock
N/C	1 2	N/C

P2 Communications

10-pin IDC

No Connect	1 2	No Connect
No Connect	3 4	Chip Select
GND	5 6	+5 VDC Out*
MOSI	7 8	SPI Clock
No Connect	9 10	MISO

*Used to power the MD-CC300-001 only.

Communications Converter p/n: MD-CC300-001

Electrically isolated in-line USB to SPI converter pre-wired with mating connector to conveniently program and set configuration parameters.

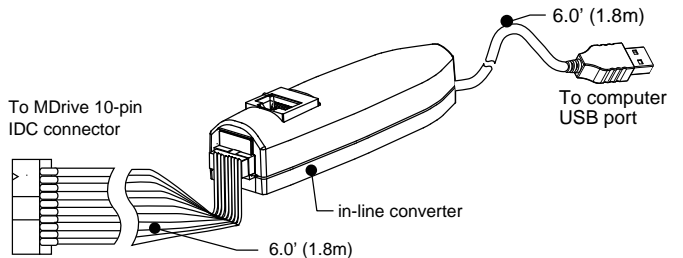

Communications Converter p/n: MD-CC303-001

Electrically isolated in-line USB to SPI converter pre-wired with mating connector to conveniently program and set configuration parameters. A secondary cable from the mating connector provides interface to power and I/O.

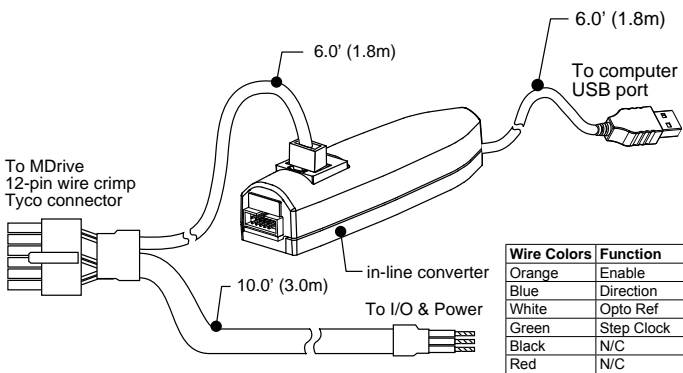

Mating Connector Kit p/n: CK-01

Use to make your own cables, kit contains 5 mating connector shells for making interface cables.

IDC Parts Shell: SAMTEC TCSD-05-01-N
Ribbon Cable: AMP 1-57051-9

P4 Optional Internal Encoder

10-pin wire crimp

N/C	9 10	N/C
IDX-	7 8	+5VDC
CH B-	5 6	IDX+
CH A-	3 4	CH B+
GND	1 2	CH A+

Prototype Development Cable p/n: PD12-1434-FL3

Speed test and development with pre-wired mating connector.

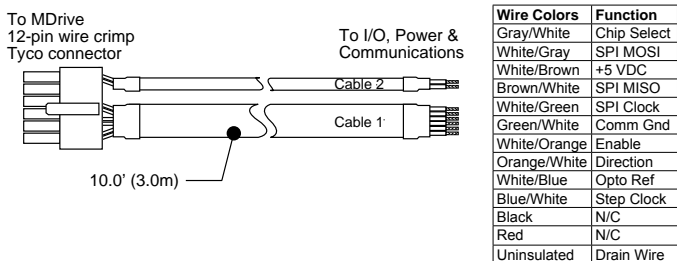

Prototype Development Cable p/n: PD10-3400-FL3

Speed test and development with pre-wired mating connector.

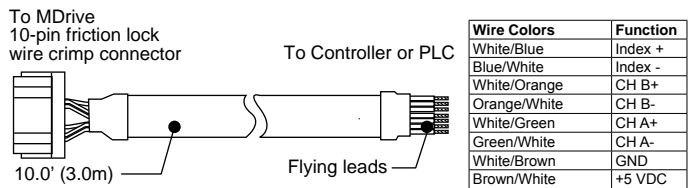

Mating Connector Kit p/n: CK-03

Use to make your own cables, kit contains 5 mating connector shells for making interface cables. Tyco crimp tool recommended.

Tyco Parts Shell: 1-794617-2
Pins: 794610-1

P3 Power

2-pin wire crimp

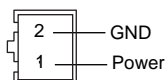

Prototype Development Cable p/n: PD02-3400-FL3

Function: Power Interface

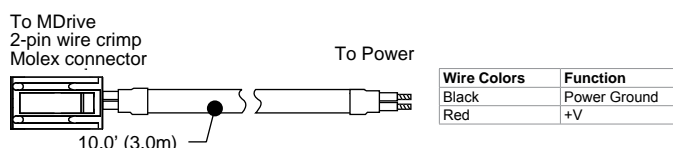

Mating Connector Kit p/n: CK-05

Use to make your own cables, kit contains 5 mating connector shells with crimp pins. Tyco crimp tool recommended.

Molex Parts Shell: 510-67-0200
Pins: 502-17-91011